







**MORE POWER : LESS NOISE**



Congratulations, you have purchased the finest exhaust system for your motorcycle on the market. Your Vance & Hines exhaust system is designed and crafted for maximum performance, a perfect fit, a great sound and unbeatable style. Please follow the installation instructions below and if you have any questions, please call our technical support line at (562) 926-5291.

Attention installer (if other than owner), please forward this instruction sheet to the owner of this product. These instructions contain valuable information to the end user.

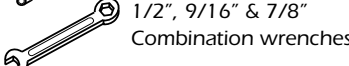
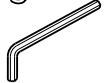
**TOOLS  
REQUIRED**

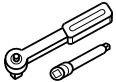
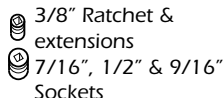
-  Flat blade & Philips screwdriver
-  5/16" Nutdriver
-  1/2", 9/16" & 7/8" Combination wrenches
-  3/16" & 1/4" Allen wrenches
-  Snapping pliers
-  3/8" Ratchet & extensions
-  7/16", 1/2" & 9/16" Sockets

**READ ALL INSTRUCTIONS BEFORE BEGINNING INSTALLATION**

**STOCK EXHAUST  
SYSTEM REMOVAL**

1. Remove seat to gain access to rear O2 sensor connector. Unplug sensor and feed end of wire through frame to free it from motorcycle. **NOTE:** Pay attention to wire routing for re-installation.
2. Remove two bolts holding rectifier onto front of frame (near front tire). Open plastic cover to gain access to front O2 sensor connector. Unplug sensor from harness. Remove cable tie holding wire to frame and feed end of wire through to free it from motorcycle.
3. Loosen heat shield clamps on both the front and rear head pipes.
4. Remove two cylinder exhaust port flange nuts from each head pipe, located at the cylinder head.
5. Remove front head pipe clamp bolt.
6. Remove the bolt that attaches mufflers to the frame mounting bar.
7. Remove the mounting bar attaching front and rear mufflers.
8. Remove the complete exhaust system and set aside (Assistance may be required).
9. Remove stock mounting bar and the studs in the transmission cover. Save the bolts, one will be re-used.
10. Remove left bolt below the transmission cover. Position mounting bracket 398-P over mounting location to determine which bolts to remove (Figure 1). Install this bolt in the top hole left vacant by the new bracket.
11. Carefully remove the flanges and circlips from the stock exhaust system using snapping pliers. **NOTE:** Replace bent or damaged circlips. Check condition of stock exhaust gaskets. Replace if worn or damaged. (Recommended replacement exhaust port gaskets, Screamin' Eagle part number 17048-98).
12. Remove stock oxygen sensors, they will be re-used on new system.

**FIGURE 1**

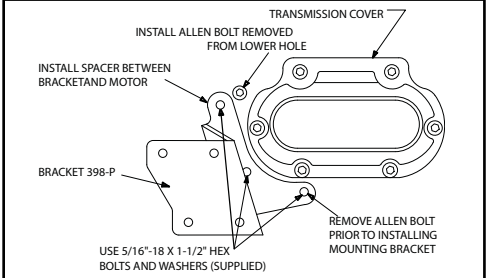

**FIGURE 2**

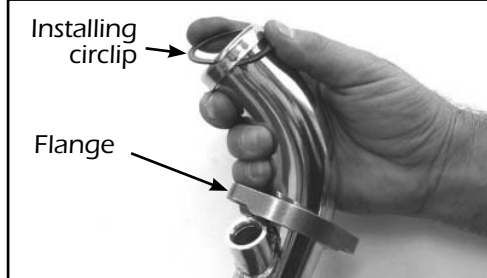

**FIGURE 3**

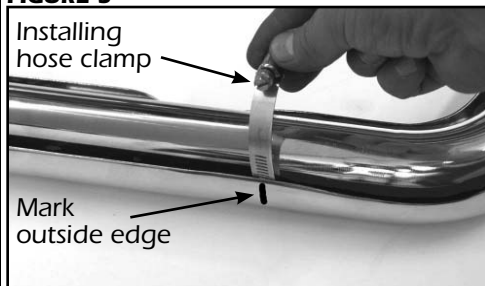

**FIGURE 4**

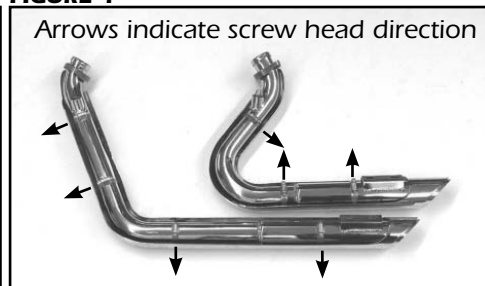

**FIGURE 5**



**FIGURE 6**



1. Attach mounting bracket 398-P (supplied) to transmission using the 11/16" spacer and three 5/16" x 1-1/2" hex bolts and 5/16" flat washer combinations (supplied) (Figure 1). NOTE: The 11/16" spacer and longer bolt are not required for 2006-2007 models.
2. Install circlips and flanges from the stock system onto both new head pipes (Figure 2).
3. Apply a small amount of anti-seize compound to the threads of the O2 sensors and install them into the new head pipes. NOTE: Be careful not to get anti-seize on sensor tip, it may affect sensor function.
4. Remove head pipes and heat shields from protective packaging. Place each heat shield on a non-abrasive surface such as a blanket or carpet. Using a pencil, lightly mark outside edge of each heat shield to show location of hose clamp mounting clips (Figure 3). NOTE: Pencil marks can be erased if care is taken not to harm coating.
5. Lay head pipes into heat shields and loosely install hose clamps by feeding tail end of clamp into heat shield clips (Figure 3). Take note of screw head direction (Figure 4). Screw head should be accessible when system is installed on motorcycle for adjustment purposes. Use #20 hose clamps for head pipe areas and #28 hose clamps for muffler areas. NOTE: Do not tighten at this time.
6. Using stock flange nuts, carefully install head pipes into exhaust ports, starting with the rear cylinder. Assistance may be required. NOTE: Do not tighten at this time.
7. Slide nut plate inside bracket that is welded to backside of muffler bodies (Figure 5). While holding nut plates in place, attach muffler bodies to mounting bracket 398-P using four 5/16" x 5/8" flange head bolts (supplied). Leave them loose at

this time. NOTE: Muffler body brackets should align with top edge of mounting bracket 398-P.

8. Tighten cylinder port exhaust flange nuts on front and rear cylinders while making sure pipes are parallel.
9. Tighten the flange bolts on both mufflers.
10. Tighten all heat shield clamps. NOTE: muffler bodies should protrude from heat shields by 1/4" (Figure 6).
11. Feed wire for front O2 sensor through frame and into plastic holder on frame. Plug sensor into stock wiring connector. Snap plastic holder closed to hold connector in place.
12. Put toothed edge of wiring holder into slot in frame. Re-install rectifier so that it fits under tooth of wiring holder, keeping it in place in frame. Tighten both bolts.
13. Install a new cable tie to hold wires onto frame in original location.
14. Feed connector for rear O2 sensor through frame and into underseat compartment. Plug sensor into stock wiring connector.
15. Re-install seat.
16. Check for adequate clearance between all exhaust system components and motorcycle accessories prone to heat damage.
17. After installation and before starting your motorcycle, completely clean pipes and mufflers with warm soapy water and a clean soft cloth. Dry with a clean towel. NOTE: any residue, oil, or fingerprints will stain the black coating. Do NOT use anything abrasive to clean the pipes as it may remove the finish.
18. Be sure to tighten all hardware before starting your motorcycle.

### EXHAUST CARE - HELPFUL HINTS TO AVOID DISCOLORATION OF EXHAUST SYSTEM

1. When installing a new set of black pipes, make sure your hands are clean and free of oil. After installation, thoroughly clean pipes with warm soapy water and a soft cloth. Dry with clean towel to remove any residue before starting the motorcycle. Do NOT use anything abrasive to clean pipes.
2. Avoid long periods of idling as this can cause discoloration.
3. Intake leaks can cause the engine to run lean and overheat, this could lead to discoloration.
4. Make sure there are no exhaust leaks at the junction of the exhaust pipes and cylinder head. We recommend replacing gaskets if they are worn.

#### FUELPAK



#### FUEL MANAGEMENT:

Take the guess work out of fuel injection with Fuelpak Fuel Management, P/N 61005. Contact your local dealer or call (562) 921-0071 to order. Visit [fuelpakfi.com](http://fuelpakfi.com) for more information.

Fuelpak is intended for racing or off-highway use only, and is not legal for sale or use in California on pollution-controlled vehicles.

#### QUIET BAFFLE



Quiet baffle P/N 21301 is available for this system. The quiet baffle will lower the sound level by 2-3db on average. Contact your local dealer to order.

PLEASE NOTE: Every effort is made for Vance & Hines Exhaust Systems to provide improved cornering clearance. However, due to design and space limitations on some motorcycle models, ground and cornering clearance may not be improved and in some cases may be reduced. Be sure to follow proper installation instructions.



**PACKING LIST**

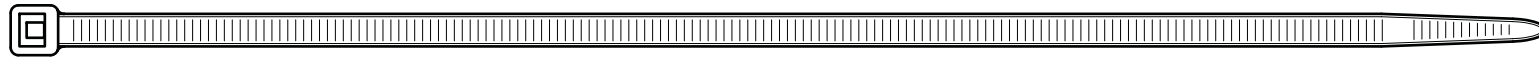

Nylon cable tie x 1

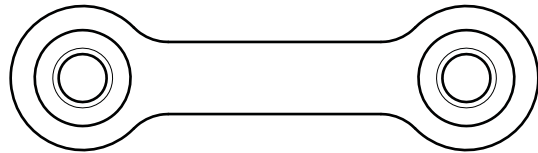

Nut plates x 2

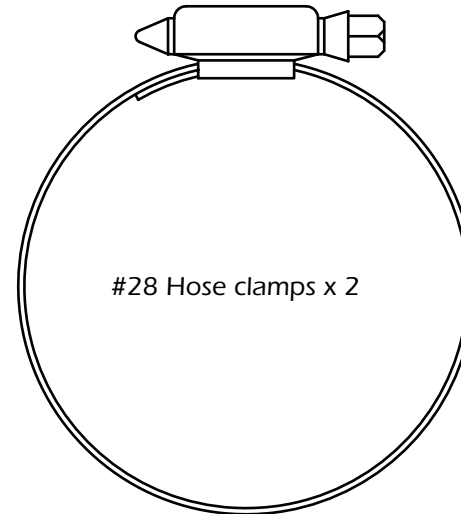

#28 Hose clamps x 2

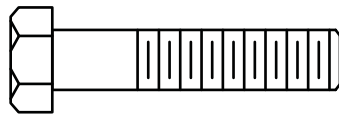

5/16" x 1-1/2" Hex head bolts x 3

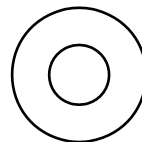

5/16" Flat washers x 3

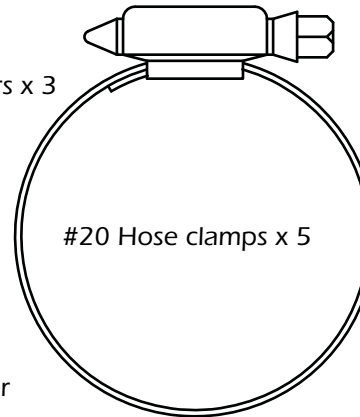

#20 Hose clamps x 5

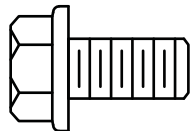

5/16" x 5/8" Flange head bolts x 4

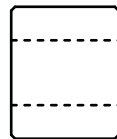

1 1/16" x 9/16" Spacer

**PARTS NOT SHOWN:**

- 398-P Bracket x 1
- D410FC Front head pipe x 1
- D411FC Rear head pipe x 1
- D412HP Front heat shield x 1
- D413HP Rear heat shield x 1

**MORE POWER : LESS NOISE**

ALL PARTS SHOWN ARE ACTUAL SIZE

**WARRANTY**

Vance & Hines exhaust systems are warranted against defects in material and workmanship for a period of 90 days from the date of purchase from an authorized dealer. This warranty does not cover discoloration of chrome finishes. This warranty is limited to the repair or replacement of a product proven to be defective from normal use. Vance & Hines exhaust systems are designed to fit and operate on OEM motor and chassis. This warranty does not cover any product subject to abuse, misuse, improper installation or modification.

## FUEL MANAGEMENT

**GET THE MOST OUT OF YOUR RIDING EXPERIENCE...**

AN AFTERMARKET EXHAUST SYSTEM IS ONLY YOUR FIRST STEP, NOW YOU NEED FUEL MANAGEMENT.

### **NOW YOU NEED FUELPAK.**

Your fuel injected Harley-Davidson® is equipped with an ECU (electronic control unit) that's programmed to deliver fuel to the motor based on an air/fuel ratio for a stock air filter and stock exhaust system. When you install a performance exhaust system, your airflow changes, so you need a fuel management system that adjusts your air/fuel ratio to match the changes. That fuel management system is Fuelpak. Fuelpak adds and takes away fuel, allowing for a more precise range of refinement in your air/fuel ratio. Get the perfect fuel management combination with your Vance & Hines exhaust system, get Fuelpak. For more information visit the tuning center at [fuelpakfi.com](http://fuelpakfi.com)

NOTICE: Fuelpak is intended for racing or off-highway use only, and is not legal for sale or use in California on pollution-controlled vehicles.



**MORE POWER : LESS NOISE**

**13861 ROSECRANS AVENUE / SANTA FE SPRINGS, CA 90670**  
**SALES: (562) 921-7461 / TECHNICAL: (562) 926-5291 / FAX: (562) 802-0110**  
**VANCEANDHINES.COM**